

DENON

Control Dock for iPod®

ASD-3W

Owner's Manual
Bedienungsanleitung
Manuel de l'Utilisateur
Manuale delle istruzioni
Manual del usuario
Gebruiksaanwijzing
Bruksanvisning



iPod is a trademark of Apple Inc., registered in the U.S. and other countries.

GUI *Graphical User Interface*

English

GUI Menu Operations (👉 page 10)
GUI Menu Map (👉 page 11)

Deutsch

GUI-Menübedienung (👉 Seite 10)
GUI-Menüplan (👉 Seite 11)

Français

Fonctionnement du menu de l'interface graphique GUI (👉 page 10)
Plan du menu de l'interface graphique GUI (👉 page 11)

Italiano

Operazioni menu GUI (👉 pagina 10)
Mappa menu GUI (👉 pagina 11)

Español

Uso de los menús GUI (👉 página 10)
Estructura de los menús GUI (👉 página 11)

Nederlands

Het GUI menu bedienen (👉 blz. 10)
Overzicht van het GUI menu (👉 blz. 11)

Svenska

Användning av GUI-menyer
(👉 sidan 10)
GUI-menyoversikt (👉 sidan 11)

SAFETY INSTRUCTIONS

1. Read Instructions – All the safety and operating instructions should be read before the product is operated.
2. Retain Instructions – The safety and operating instructions should be retained for future reference.
3. Heed Warnings – All warnings on the product and in the operating instructions should be adhered to.
4. Follow Instructions – All operating and use instructions should be followed.
5. Cleaning – Unplug this product from the wall outlet before cleaning. Do not use liquid cleaners or aerosol cleaners.
6. Attachments – Do not use attachments not recommended by the product manufacturer as they may cause hazards.
7. Water and Moisture – Do not use this product near water – for example, near a bath tub, wash bowl, kitchen sink, or laundry tub; in a wet basement; or near a swimming pool; and the like.
8. Accessories – Do not place this product on an unstable cart, stand, tripod, bracket, or table. The product may fall, causing serious injury to a child or adult, and serious damage to the product. Use only with a cart, stand, tripod, bracket, or table recommended by the manufacturer, or sold with the product. Any mounting of the product should follow the manufacturer's instructions, and should use a mounting accessory recommended by the manufacturer.
9. A product and cart combination should be moved with care. Quick stops, excessive force, and uneven surfaces may cause the product and cart combination to overturn.
10. Ventilation – Slots and openings in the cabinet are provided for ventilation and to ensure reliable operation of the product and to protect it from overheating, and these openings must not be blocked or covered. The openings should never be blocked by placing the product on a bed, sofa, rug, or other similar surface. This product should not be placed in a built-in installation such as a bookcase or rack unless proper ventilation is provided or the manufacturer's instructions have been adhered to.
11. Power Sources – This product should be operated only from the type of power source indicated on the marking label. If you are not sure of the type of power supply to your home, consult your product dealer or local power company. For products intended to operate from battery power, or other sources, refer to the operating instructions.



12. Grounding or Polarization – This product may be equipped with a polarized alternating-current line plug (a plug having one blade wider than the other). This plug will fit into the power outlet only one way. This is a safety feature. If you are unable to insert the plug fully into the outlet, try reversing the plug. If the plug should still fail to fit, contact your electrician to replace your obsolete outlet. Do not defeat the safety purpose of the polarized plug.

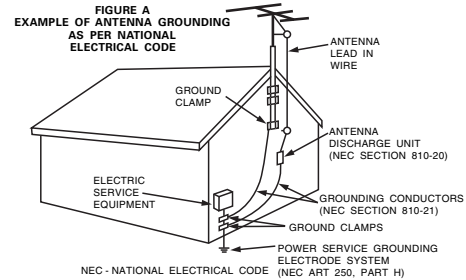

13. Power-Cord Protection – Power-supply cords should be routed so that they are not likely to be walked on or pinched by items placed upon or against them, paying particular attention to cords at plugs, convenience receptacles, and the point where they exit from the product.
15. Outdoor Antenna Grounding – If an outside antenna or cable system is connected to the product, be sure the antenna or cable system is grounded so as to provide some protection against voltage surges and built-up static charges. Article 810 of the National Electrical Code, ANSI/NFPA 70, provides information with regard to proper grounding of the mast and supporting structure, grounding of the lead-in wire to an antenna discharge unit, size of grounding conductors, location of antenna-discharge unit, connection to grounding electrodes, and requirements for the grounding electrode. See Figure A.
16. Lightning – For added protection for this product during a lightning storm, or when it is left unattended and unused for long periods of time, unplug it from the wall outlet and disconnect the antenna or cable system. This will prevent damage to the product due to lightning and power-line surges.
17. Power Lines – An outside antenna system should not be located in the vicinity of overhead power lines or other electric light or power circuits, or where it can fall into such power lines or circuits. When installing an outside antenna system, extreme care should be taken to keep from touching such power lines or circuits as contact with them might be fatal.

18. Overloading – Do not overload wall outlets, extension cords, or integral convenience receptacles as this can result in a risk of fire or electric shock.
19. Object and Liquid Entry – Never push objects of any kind into this product through openings as they may touch dangerous voltage points or short-out parts that could result in a fire or electric shock. Never spill liquid of any kind on the product.
20. Servicing – Do not attempt to service this product yourself as opening or removing covers may expose you to dangerous voltage or other hazards. Refer all servicing to qualified service personnel.
21. Damage Requiring Service – Unplug this product from the wall outlet and refer servicing to qualified service personnel under the following conditions:
 - a) When the power-supply cord or plug is damaged,
 - b) If liquid has been spilled, or objects have fallen into the product,
 - c) If the product has been exposed to rain or water,
 - d) If the product does not operate normally by following the operating instructions. Adjust only those controls that are covered by the operating instructions as an improper adjustment of other controls may result in damage and will often require extensive work by a qualified technician to restore the product to its normal operation,
 - e) If the product has been dropped or damaged in any way, and
 - f) When the product exhibits a distinct change in performance – this indicates a need for service.
22. Replacement Parts – When replacement parts are required, be sure the service technician has used replacement parts specified by the manufacturer or have the same characteristics as the original part. Unauthorized substitutions may result in fire, electric shock, or other hazards.
23. Safety Check – Upon completion of any service or repairs to this product, ask the service technician to perform safety checks to determine that the product is in proper operating condition.
24. Wall or Ceiling Mounting – The product should be mounted to a wall or ceiling only as recommended by the manufacturer.
25. Heat – The product should be situated away from heat sources such as radiators, heat registers, stoves, or other products (including amplifiers) that produce heat.

FCC Information (For US customers)

1. COMPLIANCE INFORMATION

Product Name: Control Dock for iPod
Model Number: ASD-3W
This product contains FCC ID: BV2- MPGBR052.

This product complies with Part 15 of the FCC Rules. Operation is subject to the following two conditions: (1) this product may not cause harmful interference, and (2) this product must accept any interference received, including interference that may cause undesired operation.

Denon Electronics (USA), LLC
 100 Corporate Drive, Marwah, NJ 07430-2041
 Tel. 201-762-6500 (Main)

2. IMPORTANT NOTICE: DO NOT MODIFY THIS PRODUCT

This product, when installed as indicated in the instructions contained in this manual, meets FCC requirements. Modification not expressly approved by DENON may void your authority, granted by the FCC, to use the product.

3. CAUTION

- To comply with FCC RF exposure compliance requirement, separation distance of at least 20 cm must be maintained between the antenna of this product and all persons.
- This product and its antenna must not be co-located or operating in conjunction with any other antenna or transmitter.

4. NOTE

This product has been tested and found to comply with the limits for a Class B digital device, pursuant to Part 15 of the FCC Rules. These limits are designed to provide reasonable protection against harmful interference in a residential installation.

This product generates, uses and can radiate radio frequency energy and, if not installed and used in accordance with the instructions, may cause harmful interference to radio communications. However, there is no guarantee that interference will not occur in a particular installation. If this product does cause harmful interference to radio or television reception, which can be determined by turning the product OFF and ON, the user is encouraged to try to correct the interference by one or more of the following measures:

- Reorient or relocate the receiving antenna.
- Increase the separation between the equipment and receiver.
- Connect the product into an outlet on a circuit different from that to which the receiver is connected.
- Consult the local retailer authorized to distribute this type of product or an experienced radio/TV technician for help.

IC Information (For Canadian customers)

1. PRODUCT

This product contains IC 6963A-MPGBR052.

This product complies with RSS-210 of Industry Canada. Operation is subject to the following two conditions: (1) this product may not cause harmful interference, and (2) this product must accept any interference received, including interference that may cause undesired operation.

This Class B digital apparatus complies with Canadian ICES-003.

APPAREIL

Cet appareil contient IC 6963A- MPGBR052.

Cet appareil est conforme à la norme CNR-210 du Canada. L'utilisation de ce dispositif est autorisée seulement aux deux conditions suivantes : (1) il ne doit pas produire de brouillage, et (2) l'utilisateur du dispositif doit être prêt à accepter tout brouillage radioélectrique reçu, même si ce brouillage est susceptible de compromettre le fonctionnement du dispositif.

Cet appareil numérique de la classe B est conforme à la norme NMB-003 du Canada.

2. CAUTION

To reduce potential radio interference to other users, the antenna type and its gain should be so chosen that the equivalent isotropically radiated power (e.i.r.p.) is not more than that permitted for successful communication.

ATTENTION

Afin de réduire le risque d'interférence aux autres utilisateurs, il faut choisir le type d'antenne et son gain de façon à ce que la puissance isotrope rayonnée équivalente (p.i.r.e.) ne soit pas supérieure au niveau requis pour l'obtention d'une communication satisfaisante.

CE 0413

R&TTE Directive 1999/5/EC

This product may be operated in the following countries;

AT	BE	CZ	DK	FI
FR	DE	GR	HU	IE
IT	NL	PL	PT	SK
ES	SE	GB	NO	CH

• DECLARATION OF CONFORMITY

Hereby, D&M Holdings Inc., Denon Brand Company declares that this product ASD-3W is in compliance with the essential requirements and other relevant provisions of Directive 1999/5/EC, in conformity with the following standards; EN60950, EN55013, EN55020, EN55022, EN55024, EN61000-3-2, EN61000-3-3, EN300328, EN301489-01, EN301489-17 and EN50371

The declaration of conformity may be consulted to our European representative, DENON Europe.

• ÜBEREINSTIMMUNGSERLÄRUNG

Hiermit erklärt D&M Holdings Inc., Denon Brand Company, dass sich das Gerät ASD-3W in Übereinstimmung mit den grundlegenden Anforderungen und den übrigen einschlägigen Bestimmungen der Richtlinie 1999/5/EG befindet, den folgenden Standards entspricht:

EN60950, EN55013, EN55020, EN55022, EN55024, EN61000-3-2, EN61000-3-3, EN300328, EN301489-01, EN301489-17 und EN50371

Wenden Sie sich bei Fragen zur Konformitätserklärung an unseren europäischen Vertreter, DENON Europe.

• DECLARATION DE CONFORMITE

Par la présente, D&M Holdings Inc., Denon Brand Company déclare que l'appareil ASD-3W est conforme aux exigences essentielles et aux autres dispositions pertinentes de la directive 1999/5/CE, e conforme alle seguenti normative:

EN60950, EN55013, EN55020, EN55022, EN55024, EN61000-3-2, EN61000-3-3, EN300328, EN301489-01, EN301489-17 e EN50371.

La déclaration de conformité pourra être consultée auprès de notre représentant en Europe, DENON Europe.

• DICHIARAZIONE DI CONFORMITÀ

Con la presente D&M Holdings Inc., Denon Brand Company dichiara che questo ASD-3W è conforme ai requisiti essenziali ed alle altre disposizioni pertinenti stabilite dalla direttiva 1999/5/CE, e conforme alle seguenti normative:

EN60950, EN55013, EN55020, EN55022, EN55024, EN61000-3-2, EN61000-3-3, EN300328, EN301489-01, EN301489-17 e EN50371.

La dichiarazione di conformità può essere consultata presso il nostro rappresentante europeo, DENON Europe.

QUESTO PRODOTTO E' CONFORME

AL D.M. 28/08/95 N. 548

• DECLARACIÓN DE CONFORMIDAD

Por la presente, D&M Holdings Inc., Denon Brand Company, declara que este ASD-3W cumple con los requisitos esenciales y otras exigencias relevantes de la Directiva 1999/5/EC, esta conforme con los siguientes estandares:

EN60950, EN55013, EN55020, EN55022, EN55024, EN61000-3-2, EN61000-3-3, EN300328, EN301489-01, EN301489-17 y EN50371.

Puede consultar a nuestro representante europeo, DENON Europe, acerca de la declaración de conformidad.

• EENVORMIGHEIDSVERKLARING

Hierbij verklaart D&M Holdings Inc., Denon Brand Company dat het toestel ASD-3W in overeenstemming is met de essentiële eisen en de andere relevante bepalingen van richtlijn 1999/5/EG, in overeenstemming is met de volgende normen:

EN60950, EN55013, EN55020, EN55022, EN55024, EN61000-3-2, EN61000-3-3, EN300328, EN301489-01, EN301489-17 en EN50371.

De eenvormigheidsverklaring mag worden geconsulteerd aan onze Europese vertegenwoordiger, DENON Europa.

• ÖVERENSSTÄMMELSESI NTY

Denna utrustning är i överensstämmelse med de väsentliga kraven och andra relevanta bestämmelser i Direktiv 1999/5/EC, uppfyller följande standarder:

EN60950, EN55013, EN55020, EN55022, EN55024, EN61000-3-2, EN61000-3-3, EN300328, EN301489-01, EN301489-17 och EN50371.

EU-konformitetsintyget kan på begäran fås från DENON Europe, vår representant i Europa.

DENON EUROPE

Division of D&M Germany GmbH

Am der Landwehr 19, Nettetal,

D-41334 Germany

CAUTION:

To completely disconnect this product from the mains, disconnect the plug from the wall socket outlet.

The mains plug is used to completely interrupt the power supply to the unit and must be within easy access by the user.

VORSICHT:

Um dieses Gerät vollständig von der Stromversorgung abzutrennen, ziehen Sie bitte den Stecker aus der Wandsteckdose.

Der Netzstecker wird verwendet, um die Stromversorgung zum Gerät völlig zu unterbrechen; er muss für den Benutzer gut und einfach zu erreichen sein.

PRECAUTION:

Pour déconnecter complètement ce produit du courant secteur, débranchez la prise de la prise murale.

La prise secteur est utilisée pour couper complètement l'alimentation de l'appareil et l'utilisateur doit pouvoir y accéder facilement.

ATTENZIONE:

Per scollegare completamente questo prodotto dalla rete di alimentazione elettrica, scollegare la spina dalla relativa presa a muro.

La spina di rete viene utilizzata per interrompere completamente l'alimentazione all'unità e deve essere facilmente accessibile all'utente.

PRECAUCIÓN:

Para desconectar completamente este producto de la alimentación eléctrica, desconecte el enchufe del enchufe de la pared.

El enchufe de la alimentación eléctrica se utiliza para interrumpir por completo el suministro de alimentación eléctrica a la unidad y debe de encontrarse en un lugar al que el usuario tenga fácil acceso.

WAARSCHUWING:

Om de voeding van dit product volledig te onderbreken moet de stekker uit het stopcontact worden getrokken. De netstekker wordt gebruikt om de stroomtoevoer naar het toestel volledig te onderbreken en moet voor de gebruiker gemakkelijk bereikbaar zijn.

FÖRSIKTIHETSMÅTT:

Koppla loss stickproppen från eluttaget för att helt skilja produkten från nätet.

Stickproppen används för att helt bryta strömförsörjningen till apparaten, och den måste vara lättillgänglig för användaren.

CAUTION:

- The ventilation should not be impeded by covering the ventilation openings with items, such as newspapers, tablecloths, curtains, etc.
- No naked flame sources, such as lighted candles, should be placed on the unit.
- Observe and follow local regulations regarding battery disposal.
- Do not expose the unit to dripping or splashing fluids.
- Do not place objects filled with liquids, such as vases, on the unit.

ACHTUNG:

- Die Belüftung sollte auf keinen Fall durch das Abdecken der Belüftungsöffnungen durch Gegenstände wie beispielsweise Zeitungen, Tischtücher, Vorhänge o. Ä. behindert werden.
- Auf dem Gerät sollten keinerlei direkte Feuerquellen wie beispielsweise angezündete Kerzen aufgestellt werden.
- Bitte beachten Sie bei der Entsorgung der Batterien die örtlich geltenden Umweltbestimmungen.
- Das Gerät sollte keiner tropfenden oder spritzenden Flüssigkeit ausgesetzt werden.
- Auf dem Gerät sollten keine mit Flüssigkeit gefüllten Behälter wie beispielsweise Vasen aufgestellt werden.

ATTENTION:

- La ventilation ne doit pas être gênée en recouvrant les ouvertures de la ventilation avec des objets tels que journaux, rideaux, tissus, etc.
- Aucune flamme nue, par exemple une bougie, ne doit être placée sur l'appareil.
- Veillez à respecter les lois en vigueur lorsque vous jetez les piles usagées.
- L'appareil ne doit pas être exposé à l'eau ou à l'humidité.
- Ne pas poser d'objet contenant du liquide, par exemple un vase, sur l'appareil.

ATTENZIONE:

- Le aperture di ventilazione non devono essere ostruite coprendole con oggetti, quali giornali, tovaglie, tende e così via.
- Non posizionate sull'unità fiamme libere, come ad esempio candele accese.
- Prestate attenzione agli aspetti legati alla tutela dell'ambiente nello smaltimento delle batterie.
- L'apparecchiatura non deve essere esposta a gocciolii o spruzzi.
- Non posizionate sull'unità alcun oggetto contenente liquidi, come ad esempio i vasi.

PRECAUCIÓN:

- La ventilación no debe quedar obstruida por haberse cubierto las aperturas con objetos como periódicos, manteles, cortinas, etc.
- No debe colocarse sobre el aparato ninguna fuente inflamable sin protección, como velas encendidas.
- A la hora de deshacerse de las pilas, respete la normativa para el cuidado del medio ambiente.
- No exponer el aparato al goteo o salpicaduras cuando se utilice.
- No colocar sobre el aparato objetos llenos de líquido, como jarros.

WAARSCHUWING:

- De ventilatie mag niet worden belemmerd door de ventilatieopeningen af te dekken met bijvoorbeeld kranten, een tafelkleed, gordijnen, enz.
- Plaats geen open vlammen, bijvoorbeeld een brandende kaars, op het apparaat.
- Houd u steeds aan de milieuvorschriften wanneer u gebruikte batterijen wegdoet.
- Stel het apparaat niet bloot aan druppels of spatten.
- Plaats geen voorwerpen gevuld met water, bijvoorbeeld een vaas, op het apparaat.

OBSERVERA:

- Ventilationen bör inte förhindras genom att täcka för ventilationsöppningarna med föremål såsom tidningar, bordsdukar, gardiner osv.
- Inga blottade brandkällor, såsom tända ljus, får placeras på apparaten.
- Tänk på miljöaspekterna när du bortskaffar batterier.
- Apparaten får inte utsättas för vätska.
- Placera inte föremål fyllda med vätska, t.ex. vaser, på apparaten.

NOTE ON USE

- Avoid high temperatures. Allow for sufficient heat dispersion when installed in a rack.
- Handle the power cord carefully. Hold the plug when unplugging the cord.
- Keep the unit free from moisture, water, and dust.
- Unplug the power cord when not using the unit for long periods of time.
- Do not obstruct the ventilation holes.
- Do not let foreign objects into the unit.
- Do not let insecticides, benzene, and thinner come in contact with the unit.
- Never disassemble or modify the unit in any way.

HINWEISE ZUM GEBRAUCH

- Vermeiden Sie hohe Temperaturen. Beachten Sie, dass eine ausreichende Belüftung gewährleistet wird, wenn das Gerät auf ein Regal gestellt wird.
- Gehen Sie vorsichtig mit dem Netzkabel um. Halten Sie das Kabel am Stecker, wenn Sie den Stecker herausziehen.
- Halten Sie das Gerät von Feuchtigkeit, Wasser und Staub fern.
- Wenn das Gerät längere Zeit nicht verwendet werden soll, trennen Sie das Netzkabel vom Netzstecker.
- Decken Sie den Lüftungsbereich nicht ab.
- Lassen Sie keine fremden Gegenstände in das Gerät kommen.
- Lassen Sie das Gerät nicht mit Insektiziden, Benzin oder Verdünnungsmitteln in Berührung kommen.
- Versuchen Sie niemals das Gerät auseinander zu nehmen oder zu verändern.

OBSERVATIONS RELATIVES A L'UTILISATION

- Éviter des températures élevées. Tenir compte d'une dispersion de chaleur suffisante lors de l'installation sur une étagère.
- Manipuler le cordon d'alimentation avec précaution. Tenir la prise lors du débranchement du cordon.
- Protéger l'appareil contre l'humidité, l'eau et la poussière.
- Débrancher le cordon d'alimentation lorsque l'appareil n'est pas utilisé pendant de longues périodes.
- Ne pas obstruer les trous d'aération.
- Ne pas laisser des objets étrangers dans l'appareil.
- Ne pas mettre en contact des insecticides, du benzène et un diluant avec l'appareil.
- Ne jamais démonter ou modifier l'appareil d'une manière ou d'une autre.

NOTE SULL'USO

- Evitate di esporre l'unità a temperature elevate. Assicuratevi che vi sia un'adeguata dispersione del calore quando installate l'unità in un mobile per componenti audio.
- Maneggiate il cavo di alimentazione con attenzione. Tenete ferma la spina quando scollegate il cavo dalla presa.
- Tenete l'unità lontana dall'umidità, dall'acqua e dalla polvere.
- Scollegate il cavo di alimentazione quando prevedete di non utilizzare l'unità per un lungo periodo di tempo.
- Non coprite i fori di ventilazione.
- Non inserite corpi estranei all'interno dell'unità.
- Assicuratevi che l'unità non entri in contatto con insetticidi, benzolo o solventi.
- Non smontate né modificate l'unità in alcun modo.

NOTAS SOBRE EL USO

- Evite altas temperaturas. Permite la suficiente dispersión del calor cuando está instalado en la consola.
- Maneje el cordón de energía con cuidado. Sostenga el enchufe cuando desconecte el cordón de energía.
- Mantenga el equipo libre de humedad, agua y polvo.
- Desconecte el cordón de energía cuando no utilice el equipo por mucho tiempo.
- No obstruya los orificios de ventilación.
- No deje objetos extraños dentro del equipo.
- No permita el contacto de insecticidas, gasolina y diluyentes con el equipo.
- Nunca desarme o modifique el equipo de ninguna manera.

ALVORENSTE GEBRUIKEN

- Vermijd hoge temperaturen. Zorg er bij installatie in een audiorack voor, dat de door het toestel geproduceerde warmte goed kan worden afgevoerd.
- Hanteer het netsnoer voorzichtig. Houd het snoer bij de stekker vast wanneer deze moet worden aan- of losgekoppeld.
- Laat geen vochtigheid, water of stof in het apparaat binnendringen.
- Neem altijd het netsnoer uit het stopcontact wanneer het apparaat gedurende een lange periode niet wordt gebruikt.
- De ventilatieopeningen mogen niet worden geblokkeerd.
- Laat geen vreemde voorwerpen in dit apparaat vallen.
- Voorkom dat insecticiden, benzene of verfvorverdunder met dit toestel in contact komen.
- Dit toestel mag niet gedemonteerd of aangepast worden.

OBSERVERA ANGÅENDE ANVÄNDNINGEN

- Undvik höga temperaturer. Se till att det finns möjlighet till god värmeavledning vid montering i ett rack.
- Hantera nätkabeln varsamt. Håll i kabeln när den kopplas från el-uttaget.
- Utsätt inte apparaten för fukt, vatten och damm.
- Koppla loss nätkabeln om apparaten inte kommer att användas i lång tid.
- Täpp inte till ventilationsöppningarna.
- Se till att främmande föremål inte tränger in i apparaten.
- Se till att inte insektsmedel på spraybruk, bensin och thinner kommer i kontakt med apparatens hölje.
- Ta inte isär apparaten och försök inte bygga om den.

A NOTE ABOUT RECYCLING:

This product's packaging materials are recyclable and can be reused. Please dispose of any materials in accordance with the local recycling regulations.

When discarding the unit, comply with local rules or regulations. Batteries should never be thrown away or incinerated but disposed of in accordance with the local regulations concerning battery disposal.

This product and the supplied accessories, excluding the batteries, constitute the applicable product according to the WEEE directive.

HINWEIS ZUM RECYCLING:

Das Verpackungsmaterial dieses Produktes ist zum Recyceln geeignet und kann wieder verwendet werden. Bitte entsorgen Sie alle Materialien entsprechend der örtlichen Recycling-Vorschriften.

Beachten Sie bei der Entsorgung des Gerätes die örtlichen Vorschriften und Bestimmungen.

Die Batterien dürfen nicht in den Hausmüll geworfen oder verbrannt werden; bitte entsorgen Sie die Batterien gemäß der örtlichen Vorschriften.

Dieses Produkt und das im Lieferumfang enthaltene Zubehör (mit Ausnahme der Batterien!) entsprechen der WEEE-Direktive.

UNE REMARQUE CONCERNANT LE RECYCLAGE:

Les matériaux d'emballage de ce produit sont recyclables et peuvent être réutilisés. Veuillez disposer des matériaux conformément aux lois sur le recyclage en vigueur.

Lorsque vous mettez cet appareil au rebut, respectez les lois ou réglementations en vigueur.

Les piles ne doivent jamais être jetées ou incinérées, mais mises au rebut conformément aux lois en vigueur sur la mise au rebut des piles.

Ce produit et les accessoires inclus, à l'exception des piles, sont des produits conformes à la directive DEEE.

NOTA RELATIVA AL RICICLAGGIO:

I materiali di imballaggio di questo prodotto sono riutilizzabili e riciclabili. Smaltire i materiali conformemente alle normative locali sul riciclaggio.

Per lo smaltimento dell'unità, osservare le normative o le leggi locali in vigore.

Non gettare le batterie, né incenerirle, ma smaltirle conformemente alla normativa locale sui rifiuti chimici.

Questo prodotto e gli accessori inclusi nell'imballaggio sono applicabili alla direttiva RAEE, ad eccezione delle batterie.

**Pb****ACERCA DEL RECICLAJE:**

Los materiales de embalaje de este producto son reciclables y se pueden volver a utilizar. Disponga de estos materiales siguiendo los reglamentos de reciclaje de su localidad.

Cuando se deshaga de la unidad, cumpla con las reglas o reglamentos locales. Las pilas nunca deberán tirarse ni incinerarse. Deberá disponer de ellas siguiendo los reglamentos de su localidad relacionados con los desperdicios químicos.

Este producto junto con los accesorios empaquetados es el producto aplicable a la directiva RAEE excepto pilas.

EEN AANTEKENING MET BETREKKING TOT DE RECYCLING:

Het inpakmateriaal van dit product is recycleerbaar en kan opnieuw gebruikt worden. Er wordt verzocht om zich van elk afvalmateriaal te ontdoen volgens de plaatselijke voorschriften.

Volg voor het wegdoen van de speler de voorschriften voor de verwijdering van wit- en bruingoed op.

Batterijen mogen nooit worden weggegooid of verbrand, maar moeten volgens de plaatselijke voorschriften betreffende chemisch afval worden verwijderd.

Op dit product en de meegeleverde accessoires, m.u.v. de batterijen is de richtlijn voor afgedankte elektrische en elektronische apparaten (WEEE) van toepassing.

OBSERVERA ANGÅENDE ÅTERTVINNING:

Produktens emballage är återvinningsbart och kan återvändas. Kassera det enligt lokala återvinningsbestämmelser.

När du kasserar enheten ska du göra det i överensstämmelse med lokala regler och bestämmelser.

Batterier får absolut inte kastas i soporna eller brännas. Kassera dem enligt lokala bestämmelser för kemiskt avfall.

Denna apparat och de tillbehör som levereras med den uppfyller gällande WEEE-direktiv, med undantag av batterierna.

1. IMPORTANT NOTICE: DO NOT MODIFY THIS PRODUCT

This product, when installed as indicated in the instructions contained in this manual, meets R&TTE directive requirements. Modification of the product could result in hazardous Radio and EMC radiation.

2. CAUTION

- Separation distance of at least 20 cm must be maintained between the antenna of this product and all persons.
- This product and its antenna must not be co-located or operating in conjunction with any other antenna or transmitter.

1. WICHTIGER HINWEIS: NEHMEN SIE KEINE VERÄNDERUNGEN AN DIESEM PRODUKT VOR

Wenn dieses Produkt entsprechend dieser Bedienungsanleitung aufgebaut wird, entspricht es den Anforderungen der R&TTE-Richtlinie. Veränderungen am Produkt können zu gefährlicher Funk- und EMV-Strahlung führen.

2. VORSICHT

- Zwischen der Antenne dieses Produkts und Personen muss ein Schutzabstand von 20 cm eingehalten werden.
- Dieses Produkt und seine Antenne dürfen nicht neben anderen Antennen oder Sendern aufgestellt oder zusammen mit ihnen verwendet werden.

1. MISE EN GARDE IMPORTANTE : NE JAMAIS MODIFIER CE PRODUIT

Si toutes les consignes indiquées dans ce mode ont été respectées pendant son installation, ce produit est conforme aux directives R&TTE. Toute modification du produit risquerait alors de générer des radiations radio et EMC dangereuses.

2. ATTENTION

- L'antenne de l'appareil devra être située à une distance de 20 cm au moins des personnes.
- Ce produit ainsi que son antenne ne devront en aucun cas être utilisés à proximité d'une autre antenne ou transmetteur.

1. AVVERTENZA IMPORTANTE: NON MODIFICARE QUESTO PRODOTTO

Se installato come indicato nelle istruzioni del presente manuale, questo prodotto soddisfa i requisiti della direttiva R&TTE. Eventuali modifiche apportate al prodotto potrebbero causare pericolose radiazioni radio ed EMC.

2. ATTENZIONE

- È necessario mantenere una distanza minima di 20 cm tra l'antenna di questo prodotto e le persone.
- Questo prodotto e la relativa antenna non devono essere posizionati in prossimità di altre antenne o trasmettitori e non devono essere utilizzati congiuntamente a questi ultimi.

1. NOTA IMPORTANTE: NO MODIFIQUE ESTE PRODUCTO

Este producto, si es instalado de acuerdo con las instrucciones contenidas en este manual, cumple los requisitos de la directiva R&TTE. La modificación del producto puede producir radiación de Radio y EMC peligrosa.

2. PRECAUCIÓN

- Se debe mantener una separación de al menos 20 cm entre la antena del producto y las personas.
- Este producto y su antena no debe instalarse ni utilizarse conjuntamente con otra antena o transmisor.

1. BELANGRIJKE MEDEDELING: BRENG AAN DIT PRODUCT GEEN AANPASSINGEN AAN

Dit product, indien geïnstalleerd volgens de aanwijzingen in deze gebruiksaanwijzing, voldoet aan de vereisten van de R&TTE-richtlijn. Aanpassing van dit product kan gevaarlijke radio- en EMC-straling tot gevolg hebben.

2. LET OP

- Houd tussen antenne en personen altijd een afstand van tenminste 20 cm aan.
- Dit product en zijn antenne mogen niet in de buurt van een andere antenne of zender worden geplaatst of in combinatie daarmee worden gebruikt.

1. VIKTIGT: APPARATEN FÅR INTE MODIFIERAS

Under förutsättning att apparaten installeras enligt anvisningarna i denna bruksanvisning, uppfyller denna kraven i R&TTE-direktivet. Ev. modifiering av apparaten kan resultera i farlig radio- och elektromagnetisk strålning.

2. FÖRSIKTIGT

- Se till att det finns ett avstånd på minst 20 cm mellan apparatens antenn och personer i omgivningen.
- Apparaten och dess antenn får inte placeras eller användas i närheten av andra antenner eller sändare.

Contents

Getting Started

Accessories	2
Cautions on Handling	2
About the Remote Control Unit	2
Before Using.....	2
Inserting the Battery.....	3
Operating Range of the Remote Control Unit.....	3
Part Names and Functions	4
Top Panel / Front Panel.....	4
Rear Panel.....	4
Remote Control Unit.....	5

Connections

Mounting the universal adapter on the control dock	6
Connection to devices equipped with Dock Control or LAN	7
Network Audio.....	8

GUI Menu Operations

Example of the Display of the GUI Mark at a Title	10
Example of Display of Default Values	10
Examples of GUI Screen Displays	10
Example: Browse Menu (Top Menu).....	10
Cursor Position Display.....	11
Operations	11
GUI Menu Map	11

Setup

Network	12
1 Network Setup.....	12
2 Network Information.....	16

Language	16
GUI	17
1 Screensaver.....	17
2 Format.....	17
3 GUI time out.....	17
Other	17
1 iPod Charge.....	17
2 Slide Show.....	17
3 Interval.....	18
4 Repeat.....	18
5 Random.....	18
6 Firmware Update.....	18

Playback

iPod® Playback	19
Preparations.....	19
Playback Music and Video.....	19
Viewing Still Pictures or Videos on the iPod.....	20
Playing Network Audio	20
Basic Operation.....	22
Listening to Internet Radio.....	23
Registering Internet Radio Stations as Your Favorites.....	23
Playing Files Stored on a Computer.....	24

Other Information	25
--------------------------------	----

Troubleshooting	27
------------------------------	----

Restart and Reset Operations	29
---	----

Specifications	30
-----------------------------	----

Getting Started

Thank you for purchasing this DENON product. To ensure proper operation, please read these owner's manual carefully before using the product. After reading them, be sure to keep them for future reference.

Accessories

Check that the following parts are supplied with the product.

- | | | |
|---|--|--------|
| ① | Owner's manual..... | 1 |
| ② | Warranty (for North America model only) | 1 |
| ③ | Service station list | 1 |
| ④ | AC Adapter (KSAFC0600150W1UV-1)..... | 1 |
| ⑤ | Remote control | 1 |
| | • RC-1087: for white model | |
| | • RC-1088: for black model | |
| ⑥ | Universal Adapter (3 types)..... | 1 each |
| ⑦ | AV/Control Cable
(Cable length: Approx. 6.6 ft/2 m) | 1 |
| ⑧ | Rod antenna for wireless LAN connection | 1 |

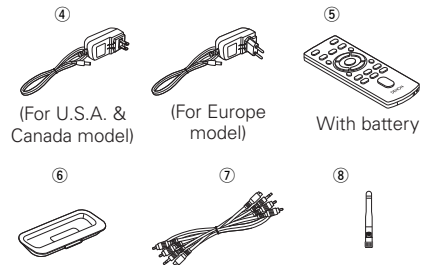

NOTE

- Do not use any AC adapter other than the specified one. Doing so could result in fires or electric shock.
- The included AC adapter is exclusively for use with this unit. Never use it with other equipment.

Cautions on Handling

Pay attention to the following before using this unit:

• Moving the unit

To prevent short-circuits or damaged wires in the connection cables, always unplug the power supply cord and disconnect the connection cables between all other audio components when moving the unit.

• Cautions on using mobile phones

Using a mobile phone near this unit may result in noise. If so, move the mobile phone away from this unit when using it.

• Store these instructions in a safe place.

After reading, store these instructions along with the warranty card in a safe place.

• Note that the illustrations in these instructions may differ from the actual unit for explanation purposes.

About the Remote Control Unit

Before Using

Remove the insulating sheet before using the remote control unit.

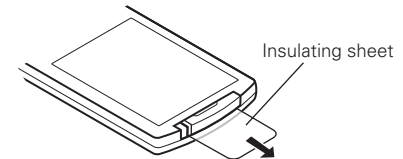

Inserting the Battery

- Remove the rear lid.
- Load the battery properly as indicated by the marks in the battery compartment.

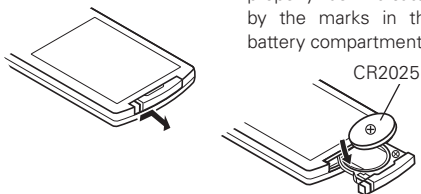

- Put the rear lid back on.

NOTE

- Replace the batteries with new ones if the set does not operate even when the remote control unit is operated close to the unit.
- The supplied batteries are only for verifying operation.
- When inserting the batteries, be sure to do so in the proper direction, following the “⊕” and “⊖” marks in the battery compartment.
- To prevent damage or leakage of battery fluid:
- Do not short-circuit, disassemble, heat or dispose of batteries in flames.
- If the battery fluid should leak, carefully wipe the fluid off the inside of the battery compartment and insert new batteries.
- Remove the batteries from the remote control unit if it will not be in use for long periods.
- When replacing the batteries, have the new batteries ready and insert them as quickly as possible.

CAUTION

RISK OF EXPLOSION IF BATTERY IS REPLACED BY AN INCORRECT TYPE.
DISPOSE OF USED BATTERIES ACCORDING TO THE INSTRUCTIONS.

Operating Range of the Remote Control Unit

Point the remote control unit at the remote sensor when operating it.

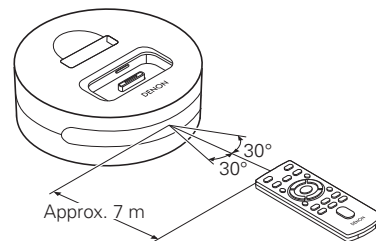

(RC-1087 or 1088)

NOTE

The set may function improperly or the remote control unit may not operate if the remote control sensor is exposed to direct sunlight, strong artificial light from an inverter type fluorescent lamp or infrared light.

Part Names and Functions

For buttons not explained here, see the page indicated in parentheses ().

Top Panel / Front Panel

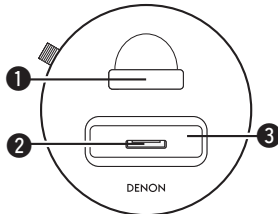

- ❶ Remote control unit storage slot
- ❷ Dock connector
- ❸ Universal adapter slot (6)

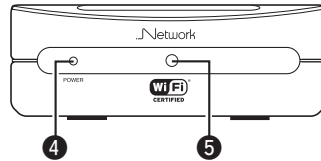

- ❹ **POWER indicator**
When the AC adapter plug is inserted into the wall socket, this unit is powered and the display illuminates. When the GUI and audio output stops the display is extinguished.
- ❺ **Remote Control sensor** (3)

Rear Panel

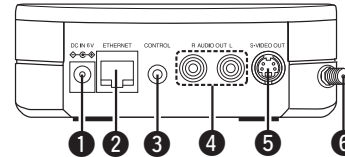

- ❶ DC IN terminal (7)
- ❷ ETHERNET connector (8)
- ❸ CONTROL terminal
(stereo mini plug) (7)
- ❹ AUDIO OUT terminals (7)
- ❺ S-VIDEO OUT terminal (7)
- ❻ WLAN ANTENNA terminal (8)

Remote Control Unit

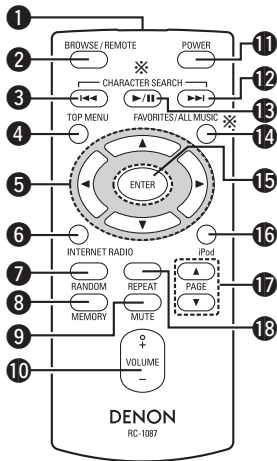

※ **CHARACTER SEARCH** and **ALL MUSIC** functions are not executed by this unit.

- 1 Remote control signal transmitter (3)
- 2 iPod mode select button (BROWSE/REMOTE) (20)
- 3 Skip Previous button (I◀◀)
- 4 TOP MENU button (11)
When pressed, the GUI's top menu appears on the monitor.
- 5 Cursor buttons (Δ▽◀▶)
- 6 INTERNET RADIO menu button (20)
When pressed, the Internet radio menu appears on the monitor.
- 7 RANDOM button
- 8 MEMORY button
- 9 Muting button (MUTE)
Turning off the sound temporarily.
- 10 VOLUME control buttons
Use this to adjust the volume.
- 11 POWER button
When this button is pressed, the GUI and audio outputs are stopped. Even when stopped (POWER indicator extinguished) the iPod is charged.
- 12 Skip Next button (▶▶I)
- 13 Play/Pause button (▶/II)
- 14 FAVORITES/ALL MUSIC button (23)
When pressed, the favorites folder appears on the monitor.
- 15 ENTER button (19)
- 16 iPod menu button
When pressed, the iPod menu appears on the monitor.
- 17 PAGE buttons (Δ▽)
- 18 REPEAT button

NOTE

While the AC adapter plug is inserted into the wall socket, this unit is in the powered state. During absence or long periods without being used, please withdraw the adapter plug from the wall socket.

Connections

Mount the included universal adapter suited for your iPod® to the control dock's universal adapter slot.

Mounting the universal adapter on the control dock



iPod is a trademark of Apple Inc., registered in the U.S. and other countries.

Bottom surface of universal adapter

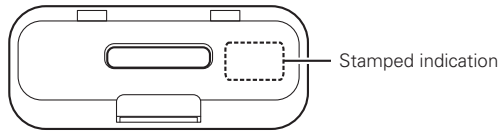

Stamped indication	iPod connectable to the ASD-3W
mini	iPod mini
Photo 20, 30GB	iPod Photo 30GB/iPod 20GB with color display
Photo 60GB	iPod Photo 60GB/iPod 40GB with color display

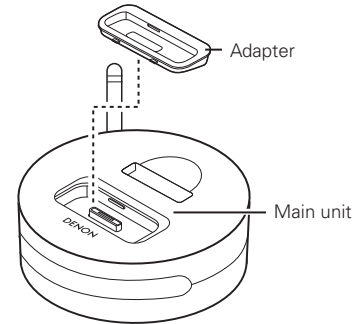

- A genuine iPod dock adapter can be mounted on this ASD-3W.
- To connect an "iPod nano" or 5th generation iPod, use the dock adapter included with the iPod.
- The 4th generation iPod (with Dock Connector) requires the Apple iPod Universal Dock Adapter 3-Pack that fits your iPod model (separately available from Apple Inc.) in order to be connected to the ASD-3W.

Connection to devices equipped with Dock Control or LAN

The ASD-3W can be operated remotely using the supplied remote control. By connecting to your existing equipment, you can play back your favourite music and video files from your iPod or from over a network.

AC outlet (wall)

AC 120 V, 60 Hz
(For U.S.A. & Canada model)
AC 230 V, 50 Hz
(For Europe model)

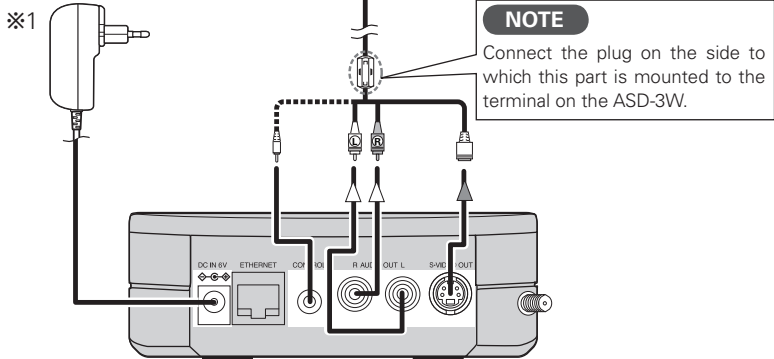
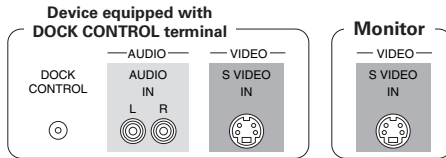

NOTE
Connect the plug on the side to which this part is mounted to the terminal on the ASD-3W.



- ※1 When the AC adapter plug is inserted into the wall socket, this unit is powered. At this time, the POWER indicator is illuminated, and after 15 ~ 20 seconds the GUI screen is displayed in the monitor.
- ※2 ASD-3W can be operated from an amplifier or system device equipped with a DOCK CONTROL terminal connected to the ASD-3W.
Features may be limited, depending on the device connected.

Latest compatible lists <http://blog.denon.com/asd-3/>.

NOTE

- When the DOCK CONTROL terminal is connected, the ASD-3W no longer accepts remote control commands. To use the remote control unit, point it at the remote control sensor on the connected device when operating it.
- Only connect equipment which is compatible with the DOCK CONTROL terminal to the CONTROL terminal of the ASD-3W. Connecting non-compatible equipment will result in a malfunction.
- While the AC adapter plug is inserted into the wall socket, this unit is in the powered state. During absence or long periods without being used, please withdraw the adapter plug from the wall socket.

Network Audio

"Network Setup" (page 12 ~ 16)

[Wired LAN]

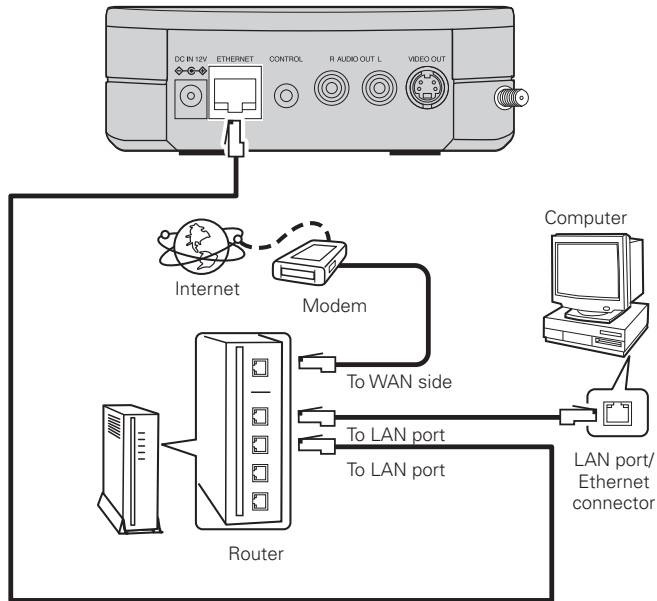

[Wireless LAN]

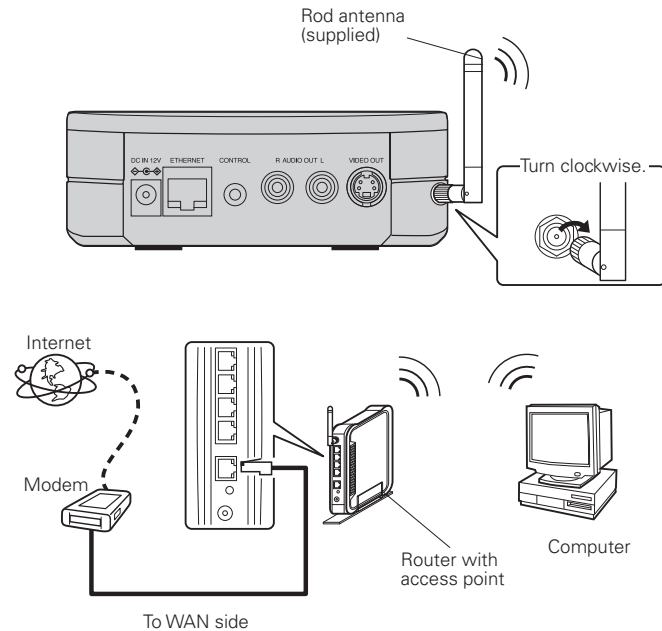

- ※ It is not possible to use both a wired and wireless LAN at the same time.
- The wired LAN mode is set automatically if a wired LAN is connected when the AC adapter is connected to a power outlet.
- The wireless LAN mode is set automatically if no wired LAN is connected when the AC adapter is connected to a power outlet.

Required system

❑ Broadband Internet connection

A broadband line connection to the Internet is required in order to use the ASD-3W's Internet radio function and firmware update.

❑ Modem

This is a device that is connected to the broadband line to communicate with the Internet. Some are integrated with the router.

❑ Router

- When using the ASD-3W, we recommend you use a router equipped with the following functions:
 - Built-in DHCP (Dynamic Host Configuration Protocol) server
This function automatically assigns IP addresses on the LAN.
 - Built-in 100BASE-TX switch
When connecting multiple devices, we recommend a switching hub with a speed of 100 Mbps or greater.
- When using with a wireless LAN, prepare a broadband router with built-in access point.

❑ Ethernet cable (CAT-5 or greater recommended)

- Use for wired LAN.
- The ASD-3W does not come with an Ethernet cable.
- Some flat type Ethernet cables are easily affected by noise.
We recommend using a normal type cable.

❑ Computer

A computer with the following specifications is required to use a music server:

- OS
Windows® XP Service Pack2, Windows Vista
 - Software (Prepare one of the following.)
 - .NET Framework 1.1 and Windows Media Connect (Windows XP)
 - Windows Media Player ver.11
 - DLNA-compatible server software
 - Internet browser
Microsoft Internet Explorer 5.01 or later
 - LAN port
 - 300 MB or more free disk space
- ※ Free disk space is required to store music and video files. The following sizes are approximate.

Format	Bit rate	Per minute	Per hour
MP3 / WMA MPEG-4 AAC	128 kbps	Approx. 1 MB	Approx. 60 MB
	192 kbps	Approx. 1.5 MB	Approx. 90 MB
	256 kbps	Approx. 2 MB	Approx. 120 MB
WAV (LPCM)	392 kbps	Approx. 3 MB	Approx. 180 MB
	1400 kbps	Approx. 10 MB	Approx. 600 MB
FLAC	1080 kbps	Approx. 7.7 MB	Approx. 464 MB



For connections to the Internet, contact an ISP (Internet Service Provider) or a computer shop.

NOTE

- A contract with an ISP is required to connect to the Internet.
No additional contract is needed if you already have a broadband connection to the Internet.
 - The types of routers that can be used depend on the ISP. Contact an ISP or a computer shop for details.
 - Depending on the server, video files may be displayed, but they cannot be played on the ASD-3W.
- ❑ Others
- If you have an Internet provider contract for a line on which network settings are made manually, make the settings at GUI menu "Setup" – "Network" – "Network Setup" (☞ page 12).
 - With the ASD-3W, it is possible to use the DHCP and Auto IP functions to make the network settings automatically.
 - When using a broadband router (DHCP function), the ASD-3W sets the IP address, etc., automatically.
When using the ASD-3W connected to a network with no DHCP function, make the settings for the IP address, etc., at GUI menu "Setup" – "Network" – "Network Setup" (☞ page 12).
 - The ASD-3W is not compatible with PPPoE. A PPPoE-compatible router is required if you have a contract for a line of the type with which the PPPoE is set.
 - Depending on the ISP with which you have your contract, it may be necessary to make proxy server settings to use the Internet radio function. If you made proxy server settings on the computer to connect to the Internet, make the proxy server settings on the ASD-3W in the same way.

GUI Menu Operations

With the ASD-3W, settings and operations for most functions can be performed by operating while looking at the GUI menus displayed on the monitor screen.

Example of the Display of the GUI Mark at a Title

Items for which this mark is indicated at the title can be operated from the GUI.

Network

Make network settings.



This is the GUI icon for this setting item or for the menu series to which this item belongs.

Example of Display of Default Values

In lists of selectable items, the item surrounded by a border is the default value.

[Selectable items] **ON** OFF

Examples of GUI Screen Displays

Some typical examples are described below.

Example: Browse Menu (Top Menu)

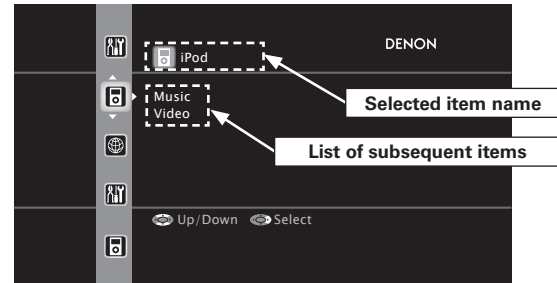

Cursor Position Display

Icon

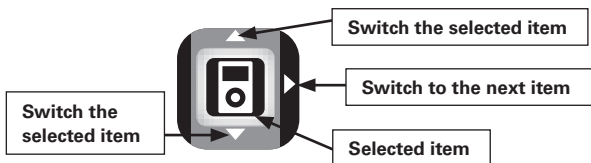

List

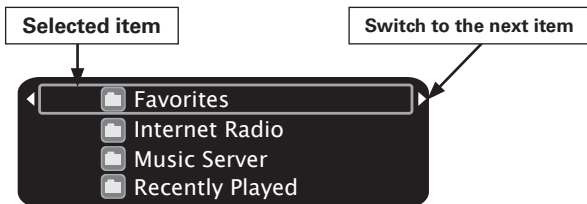

- ※ Switch the selected item using $\Delta \nabla$.
- ※ By using the **PAGE** $\Delta \nabla$ button, the list page may be sent / returned.

Operations

The same operation is possible on the remote control unit.

1 Press the $\Delta \nabla \triangleright$ button to select the menu to be set or operated.

※ To return to the previous item, press the \triangleleft button.

2 Press the **ENTER** button to enter the setting.

GUI menu map

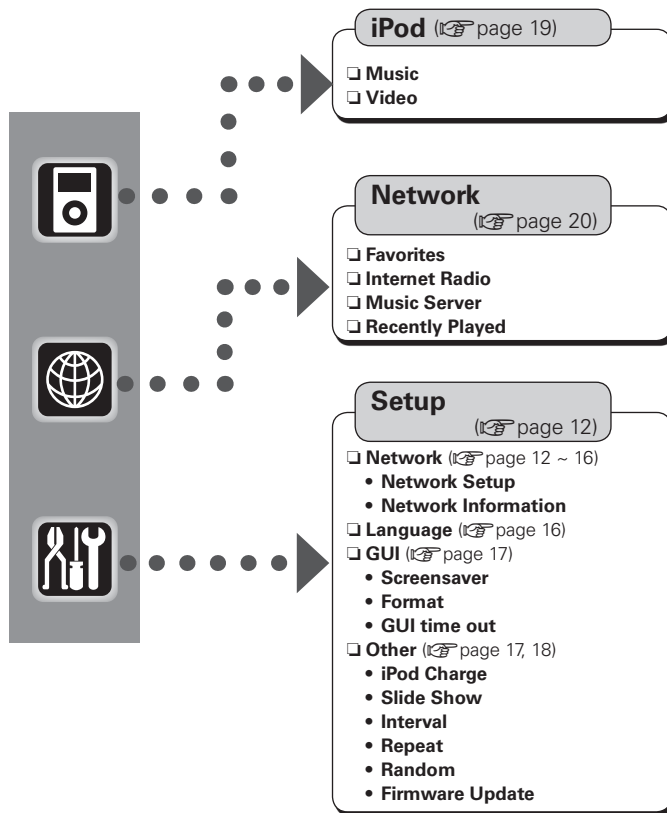

Setup



Make detail settings for various parameters.

Network

Make network settings.



Setup

Network

1 Network Setup

2 Network Information



- If you are using a broadband router (DHCP function), there is no need to make the settings at “Setting the IP Address” and “Setting the Proxy”, since the DHCP function is set to “ON” in the ASD-3W’s default settings.
- If the ASD-3W is being used connected to a network without the DHCP function, the network settings must be made. In this case, some knowledge of networks is required. For details, consult a network administrator.
- If you cannot connect to the Internet, recheck the connections and settings (☞ page 8, 9).
- If you do not understand about Internet connection, contact your ISP (Internet Service Provider) or the store from which you purchased your computer.



- **DHCP (Dynamic Host Configuration Protocol)** :
These are systems by which the IP address and other network settings are automatically set for the ASD-3W, computer, broadband router and network devices.
- **DNS (Domain Name System)** :
This is a system for converting the domain names used when browsing Internet sites (for example, “www.denon.jp”) into the IP addresses actually used for communications (for example, “202.221.192.106”).

1 Network Setup

Make settings for wired or wireless LAN.

Wired LAN settings

Use this procedure to configure the Wired LAN settings.

1 Connect the LAN cable (☞ page 8).

2 Plug the ASD-3W’s AC adapter into a wall socket (☞ page 7).

ASD-3W performs automatic network setup due to the DHCP function.
When connecting to a network that has no DHCP function, perform the setting in step 3.

3 Set the IP address at the GUI menu “Setup” – “Network” – “Network Setup”.

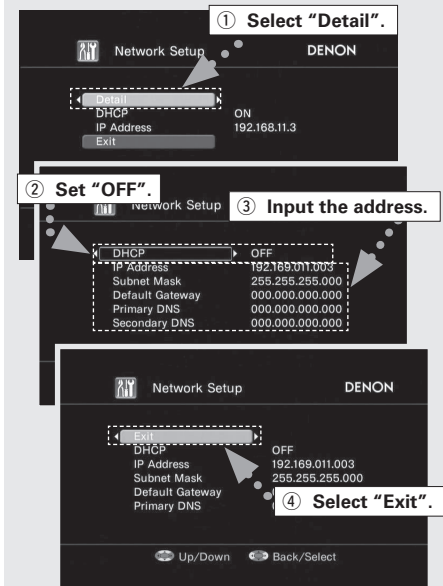

- ① Select “Detail” and press **ENTER**.
- ② Use < > to set “DHCP” to “OFF”, then press **▽**.
The DHCP function is disabled.

- ③ Use Δ ∇ \triangleright to input the address and press **ENTER**.

IP Address :

Set the IP address within the ranges shown below. The Network Audio function cannot be used if other IP addresses are set.

CLASS A: 10.0.0.0 ~ 10.255.255.255

CLASS B: 172.16.0.0 ~ 172.31.255.255

CLASS C: 192.168.0.0 ~ 192.168.255.255

Subnet Mask :

When connecting an xDSL modem or terminal adapter directly to the ASD-3W, input the subnet mask indicated in the documentation supplied by your provider. Normally input 255.255.255.0.

Default Gateway :

When connected to a gateway (router), input its IP address.

Primary DNS **Secondary DNS** :

If there is only one DNS address indicated in the documentation supplied by your provider, input it at "Primary DNS". If there are two or more DNS addresses, input the first one at "Secondary DNS".

- ④ Use ∇ to select "Exit" and press **ENTER**. Setup is complete.
- ※ When connecting to the network via a Proxy server, select "Proxy" and press **ENTER** (☞ page 16 "Proxy settings").

Wireless LAN settings

Use this procedure to configure the Wireless LAN settings.

1 Fitting a rod antenna (☞ page 8).

※ If a LAN cable is connected, remove it.

2 Plug the ASD-3W's AC adapter into a wall socket (☞ page 7).

3 Set the access point at the GUI menu "Setup" - "Network" - "Network Setup".

When searching access points to connect automatically, refer to "Automatic settings".

When searching access points to connect manually, refer to "Manual settings".

Automatic settings

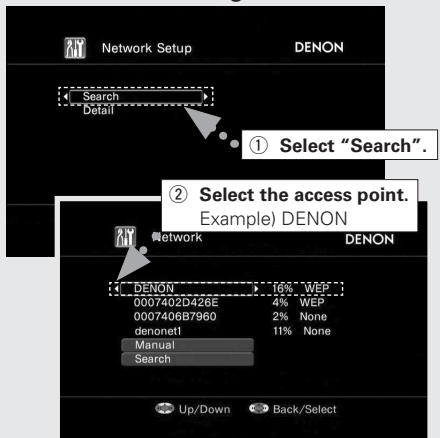

- ① Select "Search" and press **ENTER**. The access point you have set is displayed.
- ② Use Δ ∇ to select the access point, and then press **ENTER**.

※ If the access point is not detected automatically, use the "Manual settings" procedure (☞ page 14, 15).

※ If the access points are repeat search, use ∇ to select the "Search" and press **ENTER**.

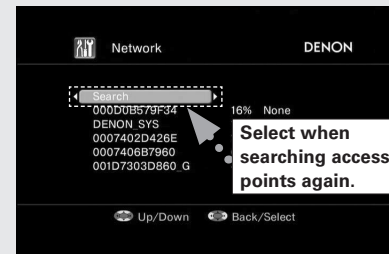

- ③ If there is an encryption setting for the access point you selected in step ②, enter same encryption key as used for the access point. (If there is no encryption setting, proceed to step ④).

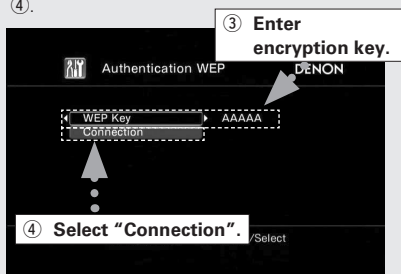

Use $\Delta \nabla \triangleleft \triangleright$ to input the "Key" (encryption key) and press **ENTER**.

Enter the same encryption key as used for the access point.

[Characters that can be input]

A ~ Z a ~ z 0 ~ 9

! " # % & ' () * + , - . / : ; < = > ? @ [\] (space)

When no security settings have been used in the Internet connection settings, this step is not necessary.

- ④ Use ∇ to select "Connection" and press **ENTER**.

Network connection starts.

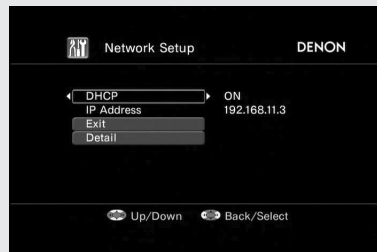

ASD-3W performs automatic network setup due to the DHCP function.

When connecting to a network that has no DHCP function, perform the setting in step 4.

- ※ When connecting to a "WEP" encrypted network, set the access point "Default Key" to "1".

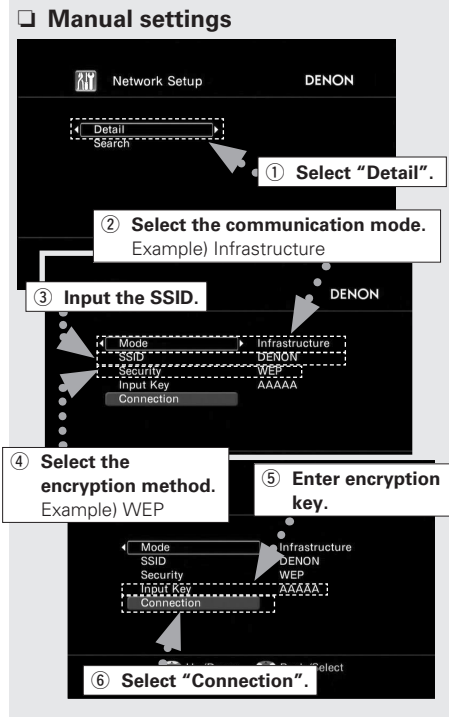

- ① Select "Detail" and press **ENTER**.
- ② Use ◀ ▶ to select the Mode and press ▾.
[Selectable items]
Infrastructure : Select when communication is via an access point.
Ad-hoc : Select during direct communication, when an access point is not used.
- ③ Use △ ▽ ◀ ▶ to input the name of the wireless network (SSID) and press **ENTER**.
[Characters that can be input]
A ~ Z a ~ z 0 ~ 9
! " # % & ' () * + , - . / : ; < = > ? @ [\] (space)
- ④ Use △ ▽ to select the Security and press ▾.
[Selectable items]
None :
 Select if not encrypted.
 Can also be used even without encryption, through we recommend encryption for improved security.
WEP WPA-PSK(TKIP) WPA-PSK(AES)
WPA2-PSK(AES) :
 Select the encryption method according to the encryption setting of the access point you are using.
 ※ When connecting to a "WEP" encrypted network, set the access point "Default Key" to "1".
- ⑤ Use △ ▽ ◀ ▶ to input the "Key" (encryption key) and press **ENTER**.
 Enter the same encryption key as used for the access point.

[Characters that can be input]
A ~ Z a ~ z 0 ~ 9
! " # % & ' () * + , - . / : ; < = > ? @ [\] (space)

When no security settings have been used in the Internet connection settings, this step is not necessary.

- ⑥ Use ▾ to select "Connection" and press **ENTER**.
 Network connection starts.

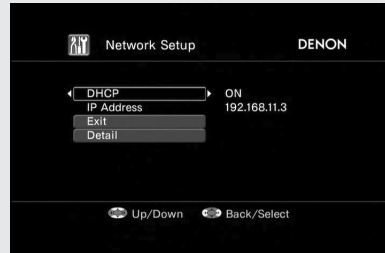

ASD-3W performs automatic network setup due to the DHCP function.
 When connecting to a network that has no DHCP function, perform the setting in step 4.

4 Set the IP address.

※ For details, see page 12, 13 "Wired LAN settings" in step 3.



If you are using a router with no DHCP function to automatically assign the IP address, set the IP address manually.

Proxy settings

Make this setting when connecting to the Internet via a proxy server.

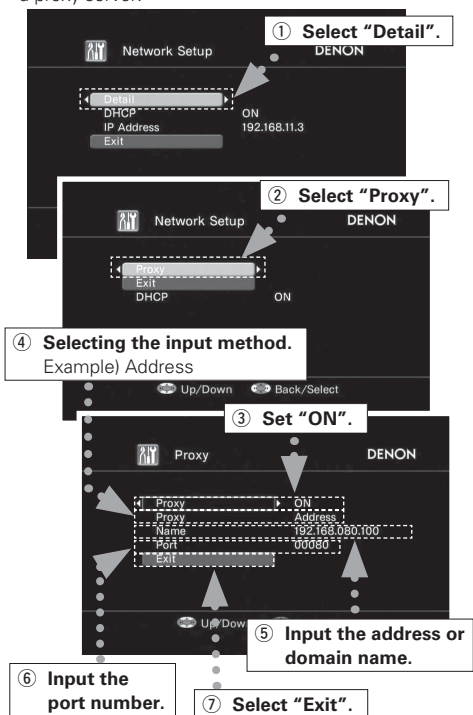

- ① On the GUI menu, select "Setup" – "Network" – "Network Setup" – "Detail" and press **ENTER**.
- ② Use $\Delta \nabla$ to set "Proxy" and press **ENTER**.
- ③ Use $\triangleleft \triangleright$ to set "Proxy" to "ON" and press ∇ . The proxy server is enabled.
- ④ Use $\triangleleft \triangleright$ to select the proxy server input method, and then press ∇ .

[Selectable items]

Address : Select when inputting by address.

Name : Select when inputting by domain name.

- ⑤ Use $\Delta \nabla \triangleright$ to input the proxy server address or domain name and press **ENTER**.
When "Address" is selected in step ④ :
Input the address
When "Name" is selected in step ④ :
Input the domain name

[Characters that can be input]

A ~ Z **a ~ z** **0 ~ 9**

! " # % & ' () * + , - . / : ; < = > ? @ [\] (space)

- ⑥ Use $\Delta \nabla \triangleleft \triangleright$ to input the proxy server port number and press **ENTER**.
- ⑦ Use ∇ to select "Exit" and press **ENTER**.
Setup is complete.

2 Network Information

Display network information.

[Items to be checked]

SSID **DHCP= ON or OFF** **IP Address**

MAC Address

Language

This sets the language used on the display screens



Setup

Language

[Selectable items]

English

Deutsch

Français

Español

日本語

GUI

Make GUI related settings.

**Setup****GUI****1 Screensaver****2 Format****3 GUI time out****1 Screensaver**

Make screensaver settings.

Use the screensaver to prevent burn-in on the monitor screen.

When set to "ON," the screensaver is activated if there is no activity for about 3 minutes.

[Selectable items]

ON**OFF****2 Format**

Select the video output signal format to match the monitor.

[Selectable items]

NTSC **PAL**

※ Normally there is no need to set this.

NOTE

When a format other than the video format of the connected monitor is set, the picture will not be displayed properly. Use the procedure described below to change the video format.

**Operating from the Remote Controller**

[Set to NTSC]

- Press and hold the **TOP MENU** and **PAGE**△ buttons for at least 3 seconds. "NTSC" is set.

[Set to PAL]

- Press and hold the **TOP MENU** and **PAGE**▽ buttons for at least 3 seconds. "PAL" is set.

3 GUI time out

Set the GUI display time when not operating.

[Selectable items]

Always**30s****10s****Other**

Make various other settings.

**Setup****Other****1 iPod Charge****2 Slide Show****3 Interval****4 Repeat****5 Random****6 Firmware Update****1 iPod Charge**

Set whether or not to charge the iPod on the ASD-3W.

[Selectable items]

ON**OFF****2 Slide Show**

Make slideshow settings.

[Selectable items]

ON**OFF**

3 Interval

Set the playback time per image.

[Selectable items]

5s 10s 15s 20s 30s 40s 60s

4 Repeat

Make settings for repeat mode.

[Selectable items]

All One OFF

5 Random

Make settings for shuffle mode.

[Selectable items]

Songs Albums OFF (iPod)

(ON) OFF (Network Audio)

※ With network audio, only the Songs Random mode works.

6 Firmware Update

Update the firmware.

You can update to the latest firmware by connecting the ASD-3W to a network.

It is recommended that you update to the latest firmware version when using the ASD-3W.

NOTE

When you update the firmware your settings will be returned to the default values. Please be aware that updating the firmware will erase all your settings, including the stations registered in your Favourites and your Recently Played list.

How to update the firmware

- ① **Connect the monitor and connect to the network.**
(☞ page 7, 8)
- ② **Plug the ASD-3W's AC adapter into a wall socket.**
(☞ page 7)
 - After about 20 ~ 30 seconds, the GUI screen will appear.
- ③ **Configure the network connection settings.**
(☞ page 12 ~ 16)
- ④ **While watching the GUI screen, use $\triangle \nabla \triangleleft \triangleright$ on the remote control unit to select "Setup" – "Other" – "Firmware Update".**
※ When the language setting is "English".

⑤ Select "Start" and press ENTER.

- When you press **ENTER**, firmware updating starts automatically.
- The message "Now Updating. During this process screen will go blank for several minutes. Do not turn off." will appear briefly, after which the GUI screen will go blank.
- The GUI screen will be blank during firmware updating, but the power indicator remains on.
- The updating process takes approx. 10 ~ 15 minutes with a broadband connection. The actual time will vary depending on the server status and the speed of the Internet.
- When updating is complete, the GUI screen reappears automatically.
- Unplug the ASD-3W's AC adapter from the wall socket. Firmware updating is now complete.

NOTE

Step ⑤ cannot take place if the ASD-3W does not connect to the Internet. In this case, repeat the procedure from step ②.



If your ASD-3W already has the latest firmware version, the message "Latest Firmware" will appear at step ⑤. In this case, you do not need to update the firmware.

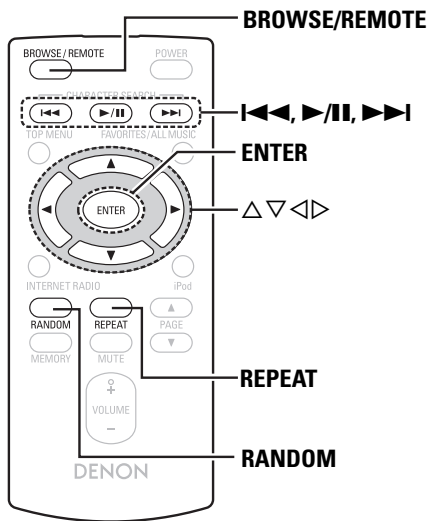

Playback

iPod® Playback



iPod is a trademark of Apple Inc., registered in the U.S. and other countries.

※ The iPod may only be used to copy or play contents that are not copyrighted or contents for which copying or playback is legally permitted for your private use as an individual. Be sure to comply with applicable copyright legislation.

Preparations

Load the iPod onto the ASD-3W.

① Set the iPod in the ASD-3W.



(iPod screen)

※ If the screens above are not displayed, the iPod may not be properly connected. Try connecting again.

NOTE

- Depending on the type of iPod and the software version, some functions may not operate.
- DENON will accept no responsibility whatsoever for any loss of iPod data.

Playback Music and Video

- 1 Use Δ ∇ to select "iPod", then press **ENTER** or \triangleright .
- 2 Use Δ ∇ to select the menu, then press **ENTER** or \triangleright to select the music or video file to be played.
- 3 Press **ENTER**, \triangleright or **▶/||**
Playback starts.

Stopping playback temporarily

During playback, press **ENTER** or **▶/||**. Press again to resume playback.

Fast-forwarding or fast-reversing

During playback, either press and hold **◀◀** or **▶▶**.

To cue to the beginning of a track

During playback, either press Δ (to cue to the previous track) or ∇ (to cue to the next track), or press **◀◀** or **▶▶**.

To stop

During playback, either press and hold **ENTER**.

Playing repeatedly

Press **REPEAT** to switch the repeat mode.

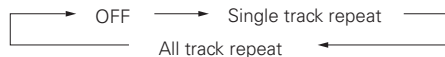

GUI: "Setup" – "Other" – "Repeat"
(page 18)



"TV Out" at the iPod's "Slideshow Settings" or "Video Settings" must be set to "ON" in order to display the iPod's photo data or videos on the monitor. For details, see the iPod's operating instructions.

Shuffling playback

Press **RANDOM** switch the shuffle mode.



GUI: "Setup" – "Other" – "Random"
(page 18)

To switch between the Browse and Remote modes

Either press and hold **BROWSE/REMOTE**.

❑ Browse mode

This mode is for operating by displaying the iPod information on the monitor connected to the ASD-3W.

In this mode, it is not possible to operate the iPod directly or to perform the operations associated with the slide show function. Set the Remote mode to play slide shows.

❑ Remote mode

This mode is for operating the iPod directly while watching the information displayed on the iPod's screen.

In this mode, the GUI operation guide is not displayed on the monitor.

Viewing Still Pictures on the iPod

Photo data on the iPod can be viewed on the monitor.

- 1** Press and hold **BROWSE/REMOTE** to set the Remote mode.
- 2** Use Δ ∇ to select the menu, then press **ENTER** or \blacktriangleright to select the file to be played.
- 3** Press **ENTER**, \blacktriangleright or **▶/||** until the image you want to view is displayed.



"TV Out" at the iPod's "Slideshow Settings" or "Video Settings" must be set to "ON" in order to display the iPod's photo data or videos on the monitor. For details, see the iPod's operating instructions.

Playing Network Audio

This procedure can be used to play Internet radio stations or music or still picture (JPEG) files stored on a computer.

❑ About the Internet radio function

- Internet radio refers to radio broadcasts distributed over the Internet. Internet radio stations from around the world can be tuned in. The ASD-3W is equipped with the following Internet radio functions:
 - Stations can be selected by genre and region.
 - Internet radio stations in MP3 and WMA (Windows Media Audio) format can be listened to.
 - Your favorite radio stations can be registered by accessing an exclusive DENON Internet radio URL from a Web browser on a computer.
 - ※ The function is managed for individual users, so you must provide your MAC or e-mail address.
 - Exclusive URL: <http://www.radiodenon.com>
- The ASD-3W's Internet radio station list is created using a radio station database service (vTuner). This database service provides a list edited and created for the ASD-3W.
 - ※ The radio station database service may be suspended without notice.

❑ Music server

This function lets you play music files and playlists (m3u, wpl) stored on a computer (music server) connected to the ASD-3W via a network.

With the ASD-3W's network audio playback function, connection to the server is possible using one of the technologies below.

- Windows Media Player Network Sharing Service
- Windows Media DRM10

[Album art function]

When a WMA (Windows Media Audio), MP3 or MPEG-4 AAC file includes album art data, the album art can be displayed while the music files are playing.



For music files in WMA (Windows Media Audio) format, the album art is only played when using Windows Media Player ver. 11.

[Slide show function]

Still picture (JPEG) files stored in folders on a music server can be played as slide shows.

The time for which each picture is displayed can be set.



When still picture (JPEG) files are played on the ASD-3W, they are played in the direction in which they are stored in the folder, so store in them in the direction in which you want them to play.

Installing Windows Media Player ver. 11

- ① If Windows XP Service Pack 2 has not yet been installed, either download it free of charge from Microsoft or install it via a Windows update installer.
 - ② Download the latest version of Windows Media Player ver. 11, either directly from Microsoft or using a Windows update installer.
- ※ When using Windows Vista, there is no need to download a new version of Windows Media Player.

[Compatible formats]

	Internet radio	Music server ※
WMA (Windows Media Audio)	○	○
MP3 (MPEG-1 Audio Layer-3)	○	○
WAV	-	○
MPEG-4 AAC	-	○*
FLAC (Free Lossless Audio Codec)	-	○
JPEG	-	○

A server or server software compatible with distribution in the corresponding formats is required to play music files via a network.

※: Only files that are not protected by copyright can be played on the ASD-3W.

Contents downloaded from pay sites on the Internet are copyright protected. Also, files encoded in WMA format when ripped from a CD, etc., on a computer may be copyright protected, depending on the computer's settings.

※ The ASD-3W is compatible with MP3 ID3-Tag (Ver. 2) standards.
The ASD-3W is compatible with WMA META tags.

[Playable formats]

	Sampling frequency	Bit rate	Extension
WMA (Windows Media Audio)	32/44.1/48 kHz	48~192 kbps	.wma
MP3 (MPEG-1 Audio Layer-3)	32/44.1/48 kHz	32~320 kbps	.mp3
WAV	32/44.1/48 kHz	-	.wav
MPEG-4 AAC	32/44.1/48 kHz	16~320 kbps	.aac/.m4a/.mp4
FLAC (Free Lossless Audio Codec)	32/44.1/48 kHz	-	.flac

WAV format Quantization bit rate: 16 bits.

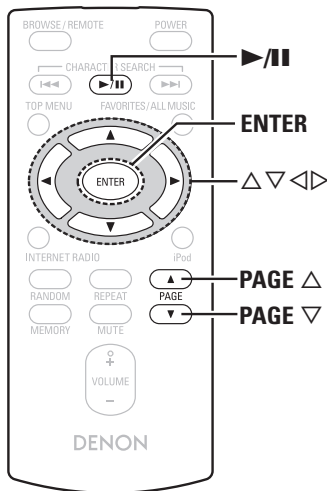

Basic Operation

1 Make the necessary preparations.

- ① Check the network environment, then turn on the ASD-3W's power.
(☞ page 8, 9 "Network Audio")
- ② If settings are required, make the network settings.
(☞ page 12 ~ 16 "Network Setup")
- ③ Prepare the computer. (☞ Computer's operating instructions)
Install "Windows Media Player ver. 11."

2 Use ▲▼ to select "Network", then press ENTER or ▶.

GUI : "Network" (☞ page 12)

3 Use ▲▼ to select the menu, then press ENTER or ▶ to select the file you want to play.

4 Press ENTER or ▶.

Playback starts.



When the network is not connected, unplug the AC adapter from the power outlet, then plug it back in and turn the power back on.

Stopping playback temporarily

During playback, press **ENTER** or **▶/||**.
Press again to resume playback.

To stop

During the play or pause mode, press and hold **ENTER**.

Searching up or down pages

Press **PAGE ▲** (up) or **PAGE ▼** (down).

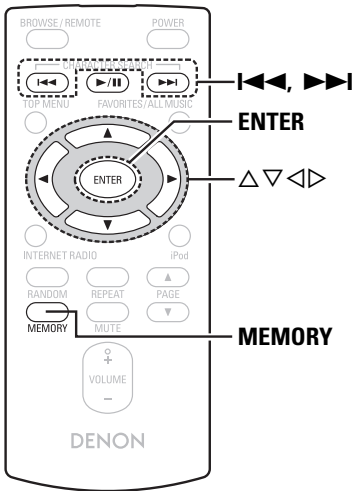

Listening to Internet Radio

- 1** Use $\Delta \nabla$ to select “Internet Radio”, then press **ENTER** or \triangleright .
- 2** Use $\Delta \nabla$ to select the item you want to play, then press **ENTER** or \triangleright .
The station list is displayed.
A “” mark is indicated in front of stations that can be played.
- 3** Use $\Delta \nabla$ to select the station, then press **ENTER** or \triangleright .
Playback starts.



There are many Internet radio stations on the Internet, and the quality of the programs they broadcast as well as the bit rate of the tracks varies widely. Generally, the higher the bit rate, the higher the sound quality, but depending on the communication lines and server traffic, the music or audio signals being streamed may be interrupted. Inversely, lower bit rates mean a lower sound quality but less tendency for the sound to be interrupted.

Recently Played Internet Radio Stations

Recently played internet radio stations can be selected from “Recently Played” in menu.

- 1** Use $\Delta \nabla$ to select “Recently Played”, then press **ENTER** or \triangleright .
- 2** Use $\Delta \nabla$ to select the item you want to play, then press **ENTER** or \triangleright .

NOTE

Up to 20 stations stored in “Recently Played”.

Registering Internet Radio Stations as Your Favorites

Favorites are listed at the top of the menu screen, so when a station is registered as a favorite it can be tuned in easily.

Press MEMORY while the Internet radio station you want to register is playing.

The Internet radio station is registered.

Listening to Internet Radio Stations Registered in Your Favorites



- 1** Use Δ / ∇ to select “Favorites”, then press **ENTER** or \triangleright .
- 2** Use Δ / ∇ to select the Internet radio station, then press **ENTER** or \triangleright .
The ASD-3W automatically connects to the Internet and playback begins.

Clearing Internet Radio Stations from Your Favorites

- 1** Use Δ / ∇ to select “Favorites”, then press **ENTER** or \triangleright .
- 2** Use Δ / ∇ to select the Internet radio station you want to clear, then press **MEMORY**.
- 3** Press \triangleright to select “Yes”.
The selected Internet radio station is cleared.
To cancel the operation without clearing the station, press \triangleleft .

Playing Files Stored on a Computer

Use this procedure to play music files, image files or playlists.

- 1** Use Δ / ∇ to select the host name of the computer on which the music file you want to play is located, then press **ENTER** or \triangleright .
- 2** Use Δ / ∇ to select the search item or folder, then press **ENTER** or \triangleright .
A “” mark is indicated in front of music files that can be played, and a “” mark is indicated in front of image files that can be played.
- 3** Use Δ / ∇ to select the file, then press **ENTER** or \triangleright .
Playback starts.

Selecting tracks

During playback, either press Δ , \blacktriangleleft (previous track) or ∇ , \blacktriangleright (next track).



- Connections to the required system and specific settings must be made in order to play music files (see page 8, 12).
- Before starting, you must launch the computer's server software and set the files as server contents. For details, see the operating instructions of your server software.
- Depending on the size of the still picture (JPEG) file, some time may be required for the file to be displayed.

Playing repeatedly

Press **REPEAT** to switch the repeat mode.

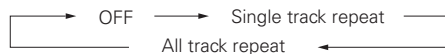
**Playing in random order**

Press **RANDOM** to switch the random mode.

**Playing files that have been Registered in Your Favorites**

Files can be registered in your favorites and played using the same operations as for Internet radio stations.

NOTE

- When the operation described below is performed, the music server's database is updated and it may no longer be possible to play preset or favorite music files.
- When you quit the music server and then restart it.
- When music files are deleted or added on the music server.
- When using an ESCIENT server, please "ESCIENT" before the server name.(North America only).

Other Information**About Networks****Windows Media Player Ver.11**

This is a media player distributed free of charge by Microsoft Corporation.

It can be used to play playlists created with Windows Media Player Ver. 11 as well as files in such formats as WMA, DRM WMA, MP3 and WAV.

vTuner

This is a free online contents server for Internet radio. Note that usage fees are included in upgrade costs.

For inquiries about this service, visit the vTuner site below.

vTuner website: <http://www.radiodeno.com>

This product is protected by certain intellectual property rights of Nothing Else Matters Software and BridgeCo. Use or distribution of such technology outside of this product is prohibited without a license from Nothing Else Matters Software and BridgeCo or an authorized subsidiary.

DLNA

- DLNA and DLNA CERTIFIED are trademarks and/or service marks of Digital Living Network Alliance.
- Some contents may not be compatible with other DLNA CERTIFIED™ products.

Windows Media DRM

A copyright-protected technology developed by Microsoft.

- Content providers are using the digital rights management technology for Windows Media contained in this device (WM-DRM) to protect the integrity of their content (Secure Content) so that their intellectual property, including copyright, in such content is not misappropriated. This device uses WM-DRM software to play Secure Content (WM-DRM Software). If the security of the WM-DRM Software in this device has been compromised, owners of Secure Content (Secure Content Owners) may request that Microsoft revoke the WM-DRM Software's right to acquire new licenses to copy, display and/or play Secure Content. Revocation does not alter the WM-DRM Software's ability to play unprotected content. A list of revoked WM-DRM Software is sent to your device whenever you download a license for Secure Content from the Internet or from a PC. Microsoft may, in conjunction with such license, also download revocation list onto your device on behalf of Secure Content Owners.

About Wireless LAN

Wi-Fi®

Wi-Fi Certification assures tested and proven interoperability by the Wi-Fi Alliance, a group certifying interoperability among wireless LAN devices.

IEEE 802.11b

This is one wireless LAN standard set by the 802 working group that establishes LAN technology standards at the IEEE (Institute of Electrical and Electronics Engineers) of the United States. It uses the 2.4 GHz band usable freely without a radio frequency license (ISM band), enabling communications at a maximum speed of 11 Mbps.



The value indicated above is the maximum theoretical value for the wireless LAN standard, and does not indicate the actual data transfer rate.

IEEE 802.11g

This is another wireless LAN standard set by the 802 working group that establishes LAN technology standards at the IEEE (Institute of Electrical and Electronics Engineers) of the United States, and is compatible with IEEE 802.11b. It also uses the 2.4 GHz band, but enables communications at a maximum speed of 54 Mbps.



The value indicated above is the maximum theoretical value for the wireless LAN standard, and does not indicate the actual data transfer rate.

Infrastructure Communications

“Infrastructure Communications” refers to networks using wireless LAN access points. This function can be used to connect to the Internet or a wired LAN via a wireless LAN access point. Wireless LAN access points include wireless broadband routers.

Ad-hoc Communications

Signal transfer through wireless interconnection of computers is referred to as “ad hoc communications”. With such ad hoc communications there is no connection to the Internet. Ad hoc communications are suited for establishing simple temporary networks.

Network Names

(SSID: Security Set Identifier)

When forming wireless LAN networks, groups are formed to prevent interference, data theft, etc. This grouping is done by “SSID” or “Security Set Identifiers”. For further security, a WEP key is set and signal transfer is not possible unless the SSID and WEP key match.

WEP Key (Network Key)

This is key information used for encrypting data when conducting data transfer. On the AVR-4308, the same WEP key is used for data encryption and decryption, so the same WEP key must be set on both devices in order for communications to be established between them.

WPA (Wi-Fi Protected Access)

This is a security standard established by the Wi-Fi Alliance. In addition to the conventional SSID (network name) and WEP key (network key), it also uses a user identification function and encrypting protocol for stronger security.

WPA2 (Wi-Fi Protected Access 2)

This is a new version of the WPA established by the Wi-Fi Alliance, compatible with more secure AES encryption.

WPA-PSK/WPA2-PSK (Pre-shared Key)

This is a simple authentication system for mutual authentication when a preset character string matches on the wireless LAN access point and client.

Passphrase

This refers to the code key used for WPA-PSK/WPA2-PSK authentication, a WPA authentication method.

TKIP (Temporal Key Integrity Protocol)

This is a network key used for WPA. The encryption algorithm is RC4, the same as for WEP, but the security level is increased by changing the network key used for encryption for each packet.

AES (Advanced Encryption Standard)

This is a next generation standard encryption method replacing the current DES and 3DES, and because of its high security it is expected to be applied widely to wireless LANs in the future. It uses the “Rijndael” algorithm developed by two Belgian cryptographers to divide the data into blocks of fixed lengths and encrypt each block. It supports data lengths of 128, 192 and 256 bits and key lengths of 128, 192 and 256 bits as well, offering extremely high encryption security.

Troubleshooting

If a problem should arise, first check the following:

1. Are the connections correct?
2. Is the set being operated as described in the owner's manual?
3. Are the other components operating properly?

If this unit does not operate properly, check the items listed in the table below. Should the problem persist, there may be a malfunction.

In this case, disconnect the power immediately and contact your store of purchase.

[General]

Symptom	Cause	Countermeasure	Page
No sound is produced. No image appears on the monitor.	<ul style="list-style-type: none"> • The iPod is not playing. • The iPod is not properly connected to the ASD-3W. 	<ul style="list-style-type: none"> • Check that the iPod is playing. • Check that the iPod is properly connected to the ASD-3W's dock connector. 	–
	<ul style="list-style-type: none"> • The AC adapter is not connected to the ASD-3W or a power outlet. • The AV/Control cable is not properly connected. • The monitor's input selection is not properly set. 	<ul style="list-style-type: none"> • Check the connections. • Set the monitor's input selector to the proper position for the connected video input terminal. 	7

[Remote Control Unit]

Symptom	Cause	Countermeasure	Page
Set does not work properly when remote control unit operated.	<ul style="list-style-type: none"> • Batteries are worn. • You are operating outside of the specified range. • Obstacle between main unit and remote control unit. 	<ul style="list-style-type: none"> • Replace with new batteries. • Operate within the specified range. • Remove the obstacle. 	3
	<ul style="list-style-type: none"> • The batteries are not inserted in the proper direction, as indicated by the polarity marks in the battery compartment. • The set's remote control sensor is exposed to strong light (direct sunlight, inverter type fluorescent bulb light, etc.). 	<ul style="list-style-type: none"> • Insert the batteries in the proper direction, following the polarity marks in the battery compartment. • Move the set to a place in which the remote control sensor will not be exposed to strong light. 	3

[NET]

Symptom	Cause	Countermeasure	Page
Internet radio cannot be played.	<ul style="list-style-type: none"> Ethernet cable is not properly connected or network is disconnected. Program is being broadcast in non-compatible format. 	<ul style="list-style-type: none"> Check the connection status. 	8
		<ul style="list-style-type: none"> Only Internet radio programs in MP3 and WMA can be played on this set. Check the computer's or router's firewall settings. Choose a radio station that is currently broadcasting. Check the set's IP address. 	21 8 – 12
Files stored on a computer cannot be played.	<ul style="list-style-type: none"> Files are stored in a non-compatible format. You are attempting to play a file that is copyright protected. 	<ul style="list-style-type: none"> Record in a compatible format. Files that are copyright protected cannot be played on this set. 	21 21
		<ul style="list-style-type: none"> The computer's or router's firewall is activated. Computer's power is not turned on. Server is not running. Set's IP address is wrong. 	8 – – 12
Server is not found, or it is not possible to connect to the server.	<ul style="list-style-type: none"> The computer's or router's firewall is activated. Computer's power is not turned on. Server is not running. Set's IP address is wrong. 	<ul style="list-style-type: none"> Check the computer's or router's firewall settings. Turn on the power. Launch the server. Check the set's IP address. 	8 – – 12
Cannot connect to preset or favorite radio stations.	<ul style="list-style-type: none"> Radio station is not currently broadcasting. Radio station is not currently in service. 	<ul style="list-style-type: none"> Wait a while before trying again. It is not possible to connect to radio stations that are no longer in service. 	– –
		<ul style="list-style-type: none"> Station is congested or not currently broadcasting. 	–
Sound is broken during playback.	<ul style="list-style-type: none"> Network's signal transfer speed is slow or communications lines or radio station is congested. 	<ul style="list-style-type: none"> This is not a malfunction. When playing broadcast data with a high bit rate, the sound may be broken, depending on the communications conditions. 	–
Sound quality is poor or played sound is noisy.	<ul style="list-style-type: none"> File being played has a low bit rate. 	<ul style="list-style-type: none"> This is not a malfunction. 	–

[Wireless LAN]

Symptom	Cause	Countermeasure	Page
Cannot connect to network.	<ul style="list-style-type: none"> The settings of the SSID and network key (WEP) are incorrect. The reception is poor and the signals cannot be received. 	<ul style="list-style-type: none"> Match the network settings with the ASD-3W's settings. Shorten the distance from the wireless LAN's access point, remove any obstacles and otherwise improve visibility, then try reconnecting. Also install away from microwave ovens and the access points of other networks. 	13 ~ 15 –
Played sound is interrupted or sound cannot be played.	<ul style="list-style-type: none"> There are multiple networks and the usable channels overlap. 	<ul style="list-style-type: none"> Set the access point's channel settings away from the channels used for other networks. Alternatively, connect using a network cable. 	–
	<ul style="list-style-type: none"> There are multiple networks and the usable channels overlap. 	<ul style="list-style-type: none"> Set the access point's channel settings away from the channels used for other networks. Alternatively, connect using a network cable. 	–

Restart and Reset Operations

If a fault occurs during use of the ASD-3W, for example, if you cannot connect to a network although the network settings are correct, or the iPod cannot be detected or the remote control unit does not work, you may be able to resolve the problem by taking the following action.

- ❑ **Unplug the ASD-3W's AC adapter from the wall socket and wait for about 30 seconds before plugging it back in (restart operation)**

- ❑ **Reset the ASD-3W**

Use the reset operation when you want to restore the default settings or when the restart operation has failed to resolve a fault.

NOTE

When you reset the ASD-3W, your settings will be returned to the default values. Please be aware that resetting the ASD-3W will erase all your settings, including the stations registered in your Favourites and your Recently Played list.

[How to reset the ASD-3W]

Insert a thin, pointed object (* 2) into the reset hole (* 1) and press the reset button inside the ASD-3W.

- The ASD-3W will restart automatically. The GUI screen will appear and the reset operation will be complete.

※To press the reset button inside the ASD-3W use a thin, pointed object such as a toothpick or an unfolded paper clip.

Diameter: 0.8 mm ~ 1.8 mm

Length: 30 mm or more

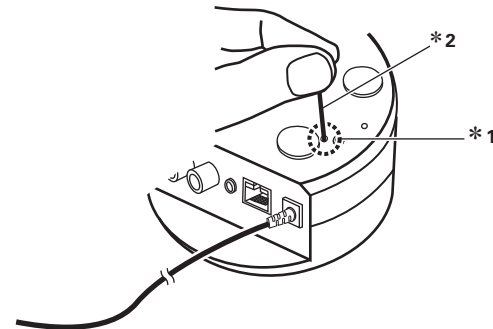

Specifications

❑ Control Dock for iPod

Power supply:	DC IN 6V
Maximum external dimensions:	120 (W) x 43.8 (H) x 120 (D) mm
Weight:	280 g
Terminal:	Analog audio output terminals x 1, S-Video output terminal x 1, Control terminal x 1 Ethernet terminal x 1 Wireless antenna terminal x 1

❑ AC Adapter (KSAFC0600150W1UV-1)

Rated voltage:	100 – 240 V, 50/60 Hz
Rated current:	0.3 A

❑ Wireless LAN

Network type (wireless LAN standards) :	Conforming to IEEE 802.11b Conforming to IEEE 802.11g (Conforming to Wi-Fi®)*
Transfer rate:	DS-SS: 11 / 5.5 / 2 / 1 Mbps (Automatic switching) OFDM: 54 / 48 / 36 / 24 / 18 / 12 / 9 / 6 Mbps (Automatic switching)
Security:	SSID (Network name) WEP key (network key) (64/128 bits) WPA-PSK (TKIP/AES) WPA2-PSK (TKIP/AES)
Used frequency range:	2,412 MHz ~ 2,472 MHz
No. of channels:	Conforming to IEEE 802.11b : 11ch (for North America), 13ch (for Europe) (DS-SS) (Of which 1 channel used) Conforming to IEEE 802.11g : 11ch (for North America), 13ch (for Europe) (OFDM) (Of which 1 channel used)

❑ Remote control unit

(RC-1087 (WHITE), RC-1088 (BLACK))

Batteries:	CR2050 Type
Maximum external dimensions:	42.5 (W) x 100 (H) x 12 (D) mm
Weight:	35 g (Approx 4 oz) (including batteries)

*: Wi-Fi® conformity indicates tested and proven interoperability by the "Wi-Fi Alliance", a group certifying interoperability among wireless LAN devices.

※ For purposes of improvement, specifications and design are subject to change without notice.

DENON

www.denon.com

Denon Brand Company, D&M Holdings Inc.
Printed in China 00D 511 4747 209